

CENTER DELIVERY FOR LATE 2025

THE SHOPS AT STONEBRIDGE

JOIN WHOLE FOODS, TJ MAXX, BARNES & NOBLE, BIRDCODE, CHIPOTLE, SHAKE SHACK

ONE SITE LEFT FOR SALE - 1.3 ACRES



CHESHIRE, CT

TOWN OF CHESHIRE, NEW HAVEN COUNTY, CONNECTICUT

107 ACRE MIXED USE PROJECT



THE SHOPS AT STONEBRIDGE

UNDER CONSTRUCTION

PROPERTY INFORMATION

New Development on 107 Acres.

...

Easy access on / off of I-84 & I-691, with ideal location right off Exit 3 of I-691.

...

Two signaled entrances to the center.

...

Retail Pads Available, Adult Housing Opportunity / Office Opportunity & Hotel coming soon.

...

Retail Shopping Center of 136,000sf.

...

Traffic Count: I-691: 49,499 vpd; Highland Ave: 12,894 vpd.

AVAILABLE SPACE

Available: 1,900sf - 3,250sf.

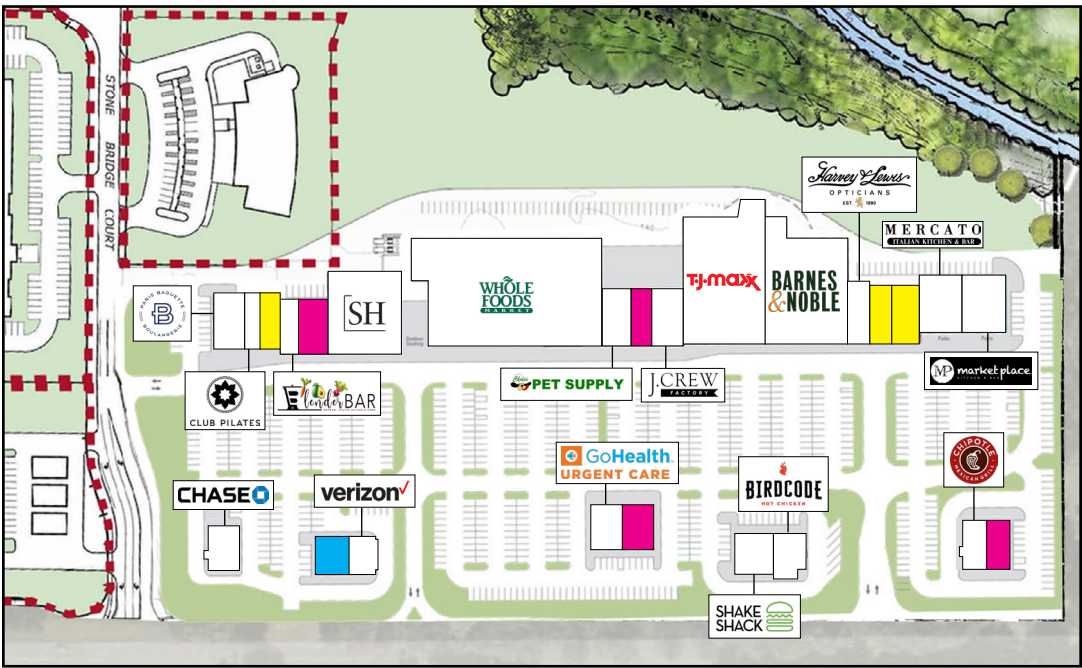

OVERALL SITE PLAN



PROPERTY LEASING PLAN - RETAIL

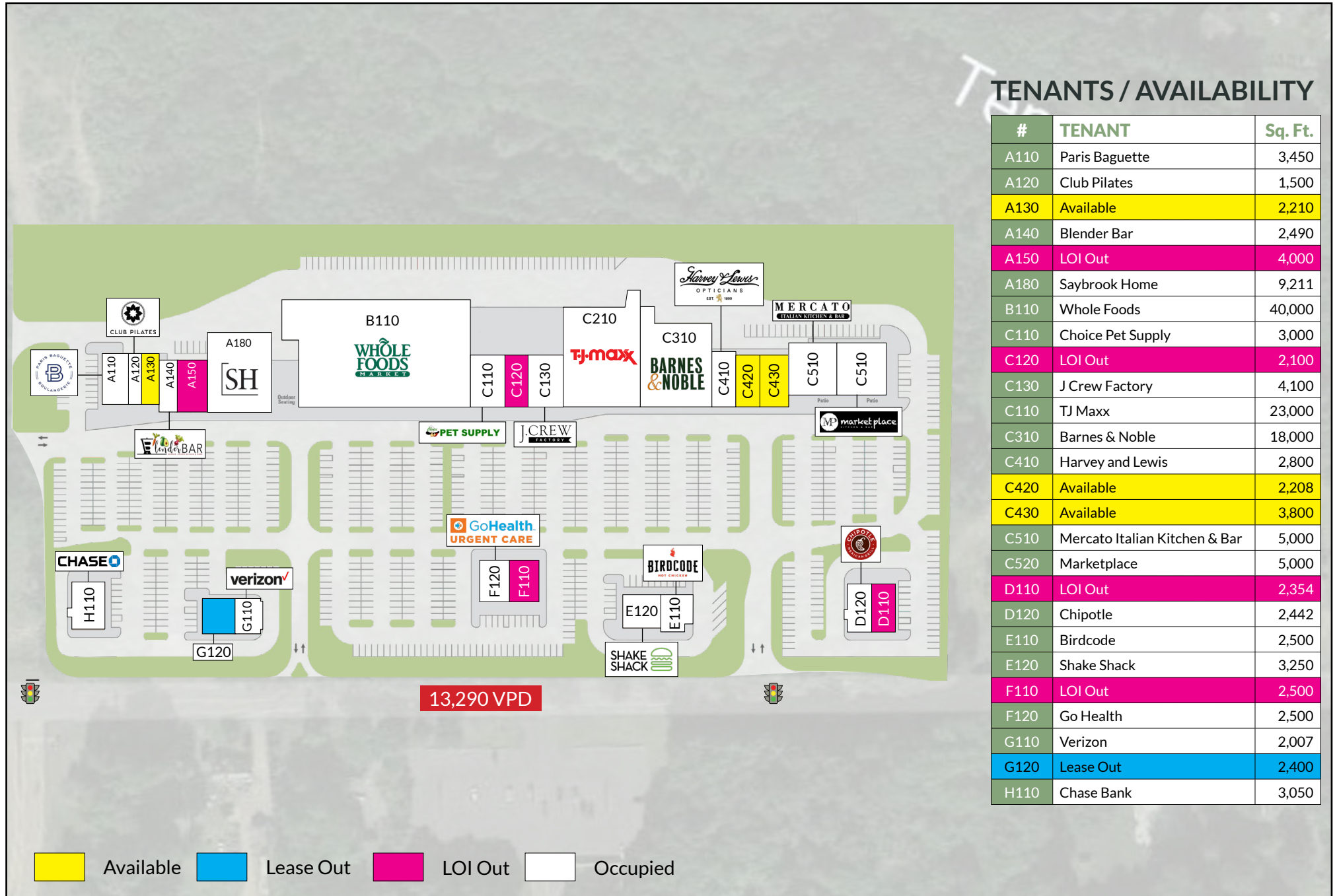

TENANTS / AVAILABILITY

#	TENANT	Sq. Ft.
A110	Paris Baguette	3,450
A120	Club Pilates	1,500
A130	Available	2,210
A140	Blender Bar	2,490
A150	LOI Out	4,000
A180	Saybrook Home	9,211
B110	Whole Foods	40,000
C110	Choice Pet Supply	3,000
C120	LOI Out	2,100
C130	J Crew Factory	4,100
C110	TJ Maxx	23,000
C310	Barnes & Noble	18,000
C410	Harvey and Lewis	2,800
C420	Available	2,208
C430	Available	3,800
C510	Mercato Italian Kitchen & Bar	5,000
C520	Marketplace	5,000
D110	LOI Out	2,354
D120	Chipotle	2,442
E110	Birdcode	2,500
E120	Shake Shack	3,250
F110	LOI Out	2,500
F120	Go Health	2,500
G110	Verizon	2,007
G120	Lease Out	2,400
H110	Chase Bank	3,050

TRADE AREA DEMOGRAPHICS

1 MILE RADIUS:



Total Population: **2,196**
 Households: **737**
 Daytime Population: **3,526**
 Median Age: **46.1**



Average Household Income: **\$137,501**
 Median Household Income: **\$106,307**

3 MILE RADIUS:



Total Population: **31,708**
 Households: **11,696**
 Daytime Population: **29,478**
 Median Age: **42.2**



Average Household Income: **\$164,752**
 Median Household Income: **\$126,954**

5 MILE RADIUS:



Total Population: **102,005**
 Households: **39,661**
 Daytime Population: **72,216**
 Median Age: **41.4**



Average Household Income: **\$139,816**
 Median Household Income: **\$107,961**

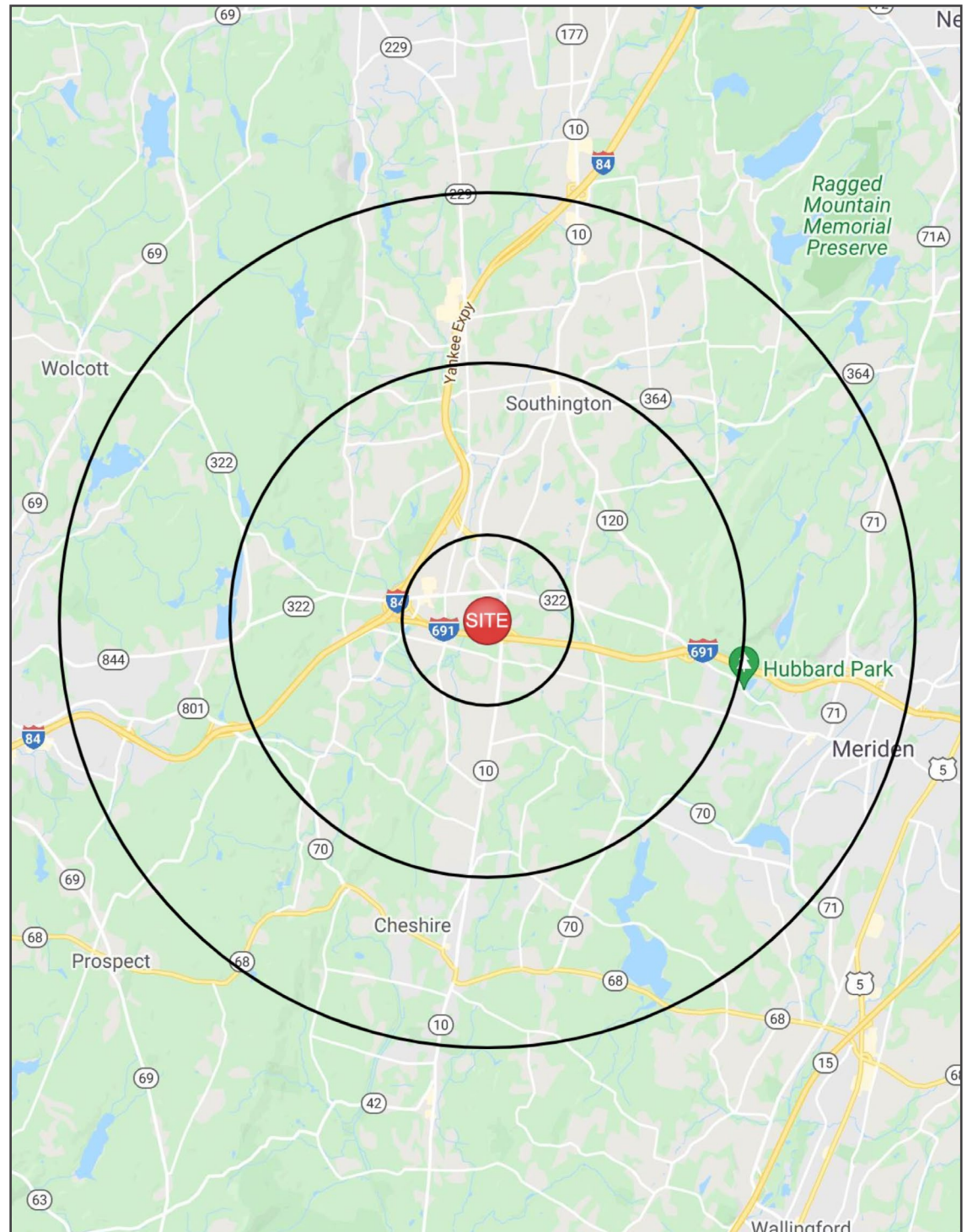

10 MINUTE DRIVE TIME

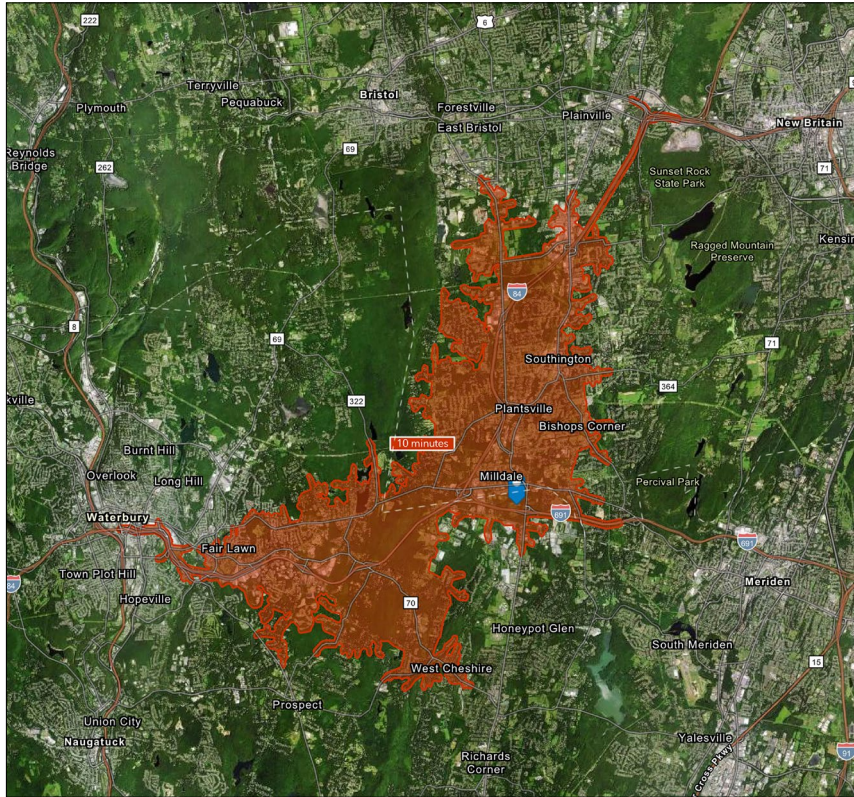

KEY FACTS

46,869

Population

42.8

Median Age

\$87,290

Median Household Income

43,163

Daytime Population

TAPESTRY SEGMENTS

Parks & Rec 5,112 Households	Front Porches 4,629 Households	Savvy Suburbanites 3,141 Households
<p>Socioeconomic Traits</p> <p>More than half of the population is college educated. This is a financially shrewd market with a diverse workforce.</p>	<p>Socioeconomic Traits</p> <p>Composed of a blue-collar workforce with a strong labor force participation rate.</p>	<p>Socioeconomic Traits</p> <p>Residents are well educated, well read, and well capitalized. Families include empty nesters. Higher labor force participation rate at 67.9%.</p>
<p>Household Types</p> <p>Married couples, approaching retirement age.</p>	<p>Household Types</p> <p>Young families w/ children, single parent families, singles living alone.</p>	<p>Household Types</p> <p>Married couples with no children or older children; average household size is 2.85.</p>
<p>Typical Housing</p> <p>Single Family</p>	<p>Typical Housing</p> <p>Single Family; Multi Units</p>	<p>Typical Housing</p> <p>Single Family</p>

TOTAL RETAIL SALES

Includes F&B



\$481,874,662

EDUCATION

Bachelor's Degree or Higher



37%

OWNER OCCUPIED HOME VALUE

Average



\$340,880

ANNUAL HOUSEHOLD SPENDING

\$3,938

Eating Out

\$2,364

Apparel & Services

\$7,307

Groceries

\$279

Computer & Hardware

\$7,714

Health Care

ELEVATIONS



① ELEVATION BUILDING A
3/32" = 1'-0"

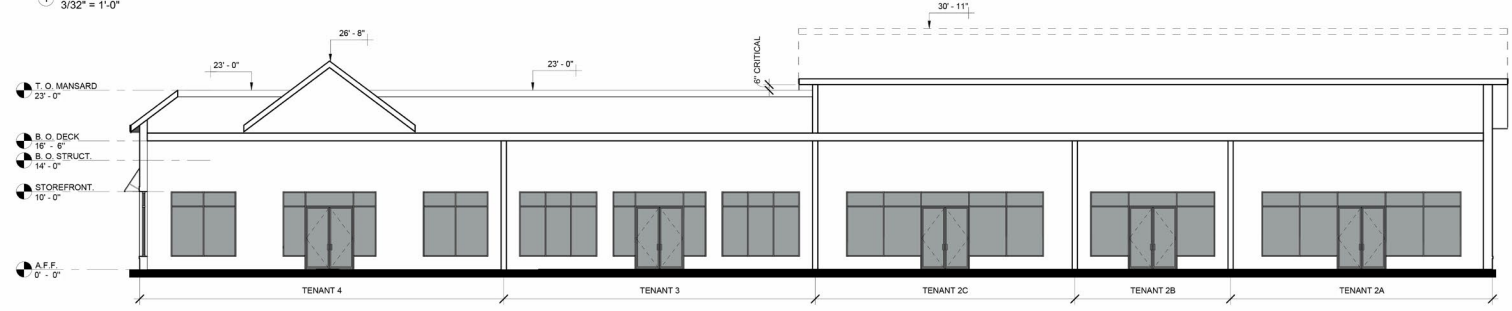

② SCHEMATIC BUILDING A SECTION
1/8" = 1'-0"

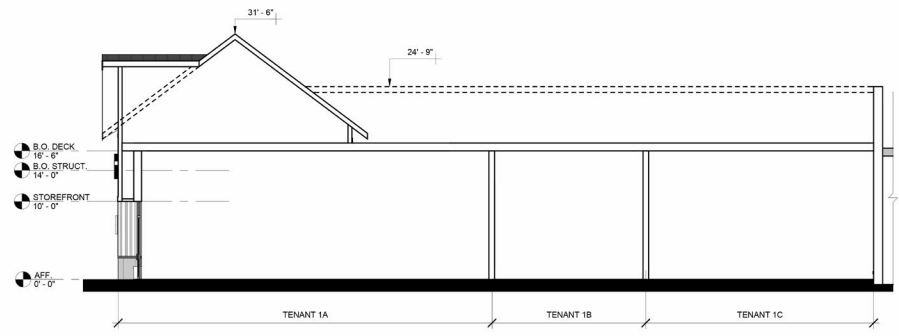

③ SCHEMATIC BUILDING A SECTION
1/8" = 1'-0"

ELEVATIONS



② ELEVATION BUILDING B
3/32" = 1'-0"

ELEVATIONS

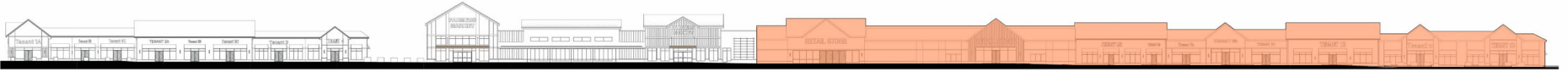

AERIAL PLAN



MARKET OVERVIEW

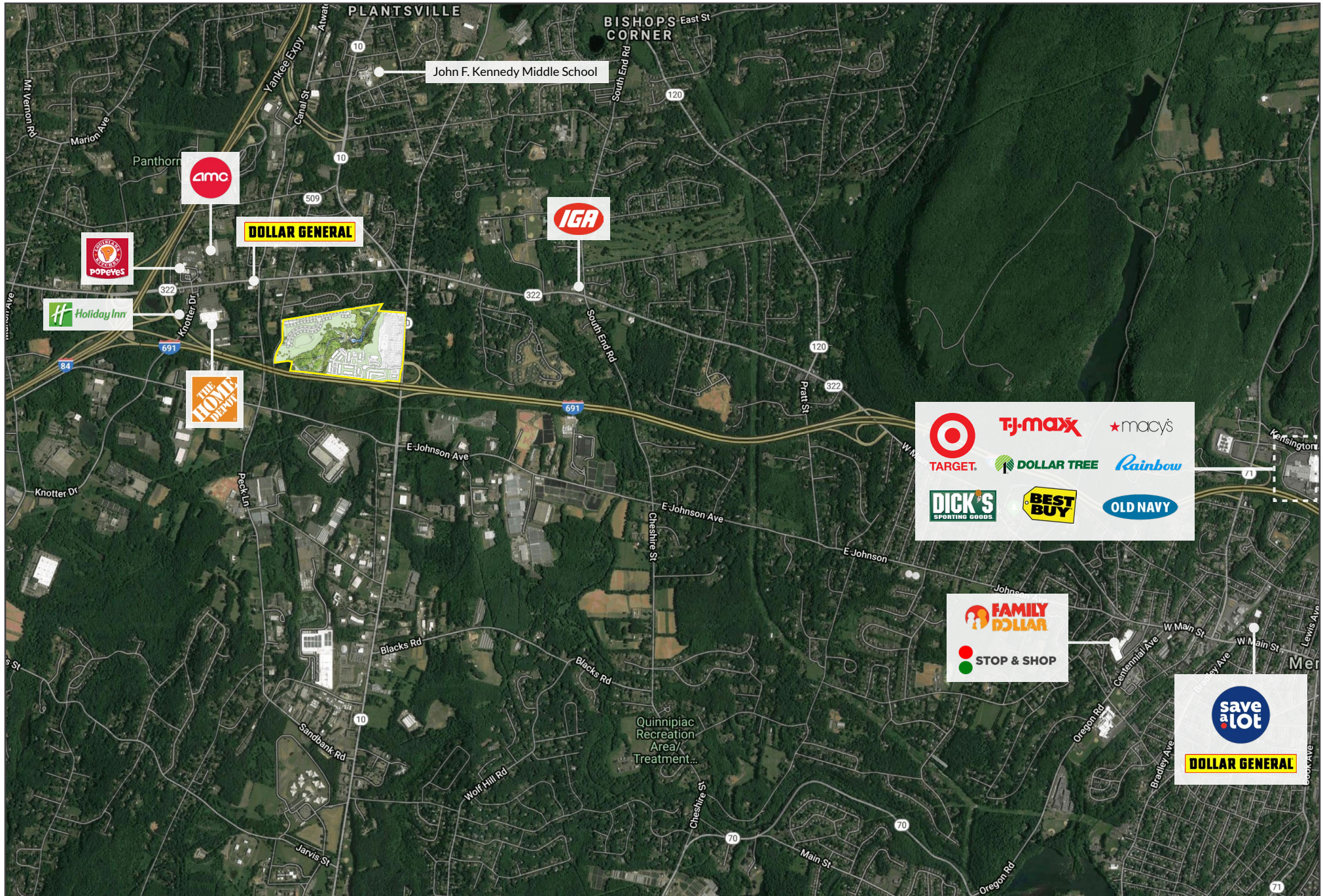

RENDERINGS



THE SHOPS AT STONEBRIDGE



CHARTER REALTY

Dan Zelson | (203) 227-2922 | Dan@CharterRealty.com

www.CharterRealty.com

The Shops At Stonebridge | Route 10 & I-691, Cheshire, CT 06410